



## Full bore magmeter, hygienic process connections

- Combination of sensor S056 and transmitter SE56
- Continuous measurement or Batch Control
- Sanitary version, 3A certification
- Dedicated to food & beverage or pharmaceutical applications
- Flow rate measurement for DN 03...DN 100

Product variants described in the data sheet may differ from the product presentation and description.

### Can be combined with



**Type 8644** ▶  
Remote Process Actuation Control System AirLINE



**Type 8693** ▶  
Digital electropneumatic process controller for the integrated mounting on process control valves

### Type description

The complete full bore magflowmeter Type 8056, which consists of a magnetic sensor Type S056 (in compact or remote version) connected to a transmitter Type SE56 (without display in compact version or with display in compact or remote version), is designed for applications with liquids with a minimum conductivity of 5  $\mu\text{S}/\text{cm}$ .





Combined with a valve as the actuating element, the complete full bore magflowmeter Type 8056 can also control high-precision dosing operations and flow measurement in food & beverage or pharmaceutical industry.

## Table of contents

<b>1. General Technical Data</b>	<b>3</b>
<hr/>	
<b>2. Product versions</b>	<b>5</b>
Compact version.....	5
Remote version.....	5
<hr/>	
<b>3. Dimensions</b>	<b>6</b>
3.1. Compact sanitary version according to DIN 11851.....	6
3.2. Remote sanitary version according to DIN 11851, with junction box.....	7
3.3. Compact sanitary version according to clamp ISO 2852 or BS 4825.....	8
3.4. Remote sanitary version according to clamp ISO 2852 or BS 4825, with junction box.....	9
<hr/>	
<b>4. Product installation</b>	<b>10</b>
4.1. Installation notes.....	10
4.2. Selection of the nominal diameter .....	11
<hr/>	
<b>5. Product operation</b>	<b>11</b>
5.1. Measuring principle .....	11
<hr/>	
<b>6. Ordering information</b>	<b>12</b>
6.1. Bürkert eShop – Easy ordering and quick delivery.....	12
6.2. Recommendation regarding product selection .....	12
6.3. Bürkert product filter .....	12
6.4. Ordering chart sensor Type S056 .....	13
6.5. Ordering chart accessories.....	15

## 1. General Technical Data

The 8056 flowmeter is available with different transmitters.  
The versions of the transmitter, Type SE56, are:

Standard compact version with display	Standard remote version with display	Basic compact version with or without display	Compact version without display
			

Detailed information can be found in the data sheet of the transmitter for electromagnetic-inductive flow sensors, see **data sheet Type SE56** ►.

### Product properties

#### Material

##### Non wetted parts

Sensor housing Stainless steel 304/1.4301

##### Wetted parts

Electrode Stainless steel 316L

Lining PTFE

Seal FKM (EPDM conform to FDA on request)

Dimensions Detailed information can be found in chapter **"3. Dimensions"** on page 6.

Pipe diameter DN 03...DN 100

Measuring principle Electromagnetic induction

Detailed information can be found in chapter **"5.1. Measuring principle"** on page 11.

Measuring range 0...10 l/h to 0...28 m<sup>3</sup>/h  
Detailed information can be found in chapter **"6.4. Ordering chart sensor Type S056"** on page 13.

### Performance data

Under reference conditions: water temperature = 20 °C, ambient temperature = 25 °C, constant flow rate during the test, liquid speed > 1 m/s

Measurement deviation If used with SE56 transmitter:

- in standard compact version: ±0.2 % of reading
- in standard remote version: ±0.2 % of reading
- in Basic compact version: ±0.8 % of reading
- in compact version without display: ±0.2 % of reading

Repeatability If used with SE56 transmitter:

- in standard compact version: ±0.1 %
- in standard remote version: ±0.1 %
- in Basic compact version: ±0.2 %
- in compact version without display: ±0.1 %

Vacuum resistance 200 mbar (2.9 PSI) absolute at 100 °C (212 °F)

### Medium data

Fluid temperature If used with SE56 transmitter:

- in standard compact version: -20...+100 °C (-4...+212 °F)
- in standard remote version: -20...+130 °C (-4...+266 °F)
- in Basic compact version: -10...+100 °C (+14...+212 °F)
- in compact version without display: -20...+100 °C (-4...+212 °F), up to +130 °C (+266 °F) for max. 1 hour

Fluid pressure PN 16

Minimum conductivity 5 µS/cm (or 20 µS/cm with demineralised water)

### Process/Port connection & communication

Process connection DIN 11851, clamp ISO 2852 or clamp BS 4825 (SMS 1146 (from DN 10) on request)

Electrical connection 2 cable glands PG9 (for remote version of the sensor)

## Approvals and certificates

### Standards

Degree of protection according to IEC/EN 60529

If use with SE56 transmitter:

- in standard compact version: IP65 and IP67
- in standard remote version:
  - IP65
  - IP68 (if the junction box of the sensor is filled with resin)
- in Basic compact version: IP65
- in compact version without display: IP65 and IP67

### Directives

CE directives

The applied standards, which verify conformity with the EU Directives, can be found on the EU Type Examination Certificate and/or the EU Declaration of conformity (if applicable).

Pressure equipment directives

The device is subject to the requirements of the Pressure Equipment Directive 2014/68/EU.

Category II device for group 1 and 2 fluids under the following conditions:

- maximum allowable pressure (PS)  $\leq$  40 bar
- minimum/maximum temperature (TS): -10/+130 °C
- within the following limits for liquids of group 2:
  - PN 40 for DN 40...DN 250
- within the following limits for liquids of group 1 with a vapour pressure at the maximum allowable temperature not exceeding 0.5 bar (g): for diameters above DN 25 and  $PS \times DN > 2000$

## Environment and installation

Ambient temperature

If used with SE56 transmitter:

- in standard compact version: -20...+60 °C (-4...+140 °F) (operation and storage)
- in standard remote version: -20...+60 °C (-4...+140 °F) (operation and storage)
- in Basic compact version:
  - -10...+50 °C (+14...+122 °F) (operating)
  - -20...+50 °C (-4...+122 °F) (storage)
- in compact version without display: -20...+40 °C (-4...+104 °F) (operation and storage)

Relative air humidity

$\leq$ 90 %, without condensation

Height above sea level

Max. 2000 m

Operating conditions

Continuous

Equipment mobility

Fixed device

Application range

Indoor and outdoor (protect the device against electromagnetic interference, ultraviolet rays and against the effects of climatic conditions)

Installation category

Category II according to UL/EN 61010-1

Pollution degree

Degree 2 according to UL/EN 61010-1

## 2. Product versions

The flowmeter Type 8056 is available in a compact or remote version.

### Compact version



A compact version of the flowmeter is made of a sensor Type S056 in a compact version and a compact transmitter Type SE56.

The compact flowmeter is also available in 3 versions depending on the used transmitter.

Product details	
Standard transmitter	With display, housing in aluminium or stainless steel
Basic transmitter	With or without display, housing in nylon
Without display transmitter	Without display, housing in stainless steel



Two different components must be ordered in order to select a complete device. The following information is required:

- **Article no.** of the compact sensor Type S056 (Detailed information can be found in chapter [“6.4. Ordering chart sensor Type S056” on page 13](#))
- **Article no.** of the compact transmitter Type SE56 (see [data sheet Type SE56](#) ▶)

### Remote version



A remote version of the flowmeter is made of a sensor Type S056 in a remote version and a remote transmitter Type SE56.

The remote flowmeter is available with the following transmitter.

Product details	
Standard transmitter	With display, housing in aluminium or stainless steel



Two different components must be ordered in order to select a complete device. The following information is required:

- **Article no.** of the remote sensor Type S056 (Detailed information can be found in chapter [“6.4. Ordering chart sensor Type S056” on page 13](#))
- **Article no.** of the remote transmitter Type SE56 (see [data sheet Type SE56](#) ▶)

### 3. Dimensions

#### 3.1. Compact sanitary version according to DIN 11851

**Note:**

- Detailed information on the dimensions of the SE56 transmitter can be found in **data sheet Type SE56** ▶.
- Dimensions in mm (unless specified differently)

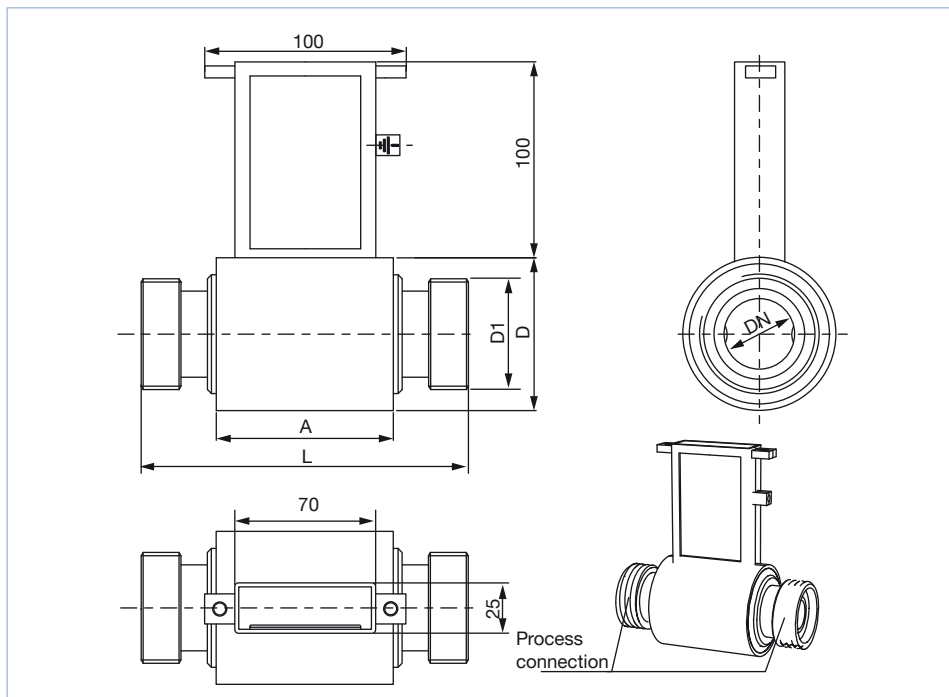

DN	A	L	Process connection	D1	D		
03	77	128	DN 10	RD28 x 1/8	76		
06				RD28 x 1/8			
10				RD28 x 1/8			
15			DN 15	RD34 x 1/8			
20			DN 20	RD44 x 1/6			
25	100	180	DN 25	RD52 x 1/6	89		
32			DN 32	RD58 x 1/6			
40			DN 40	RD65 x 1/6			
50			DN 50	RD78 x 1/6		114	
65			DN 65	RD95 x 1/6		140	
80			200	DN 80		RD110 x 1/4	168
100				DN 100		RD130 x 1/4	

DTS 1000101313 EN Version: O Status: RL (released | freigegeben | valide) printed: 27.05.2020

### 3.2. Remote sanitary version according to DIN 11851, with junction box

**Note:**

- Detailed information on the dimensions of the SE56 transmitter can be found in **data sheet Type SE56** ▶.
- Dimensions in mm (unless specified differently)

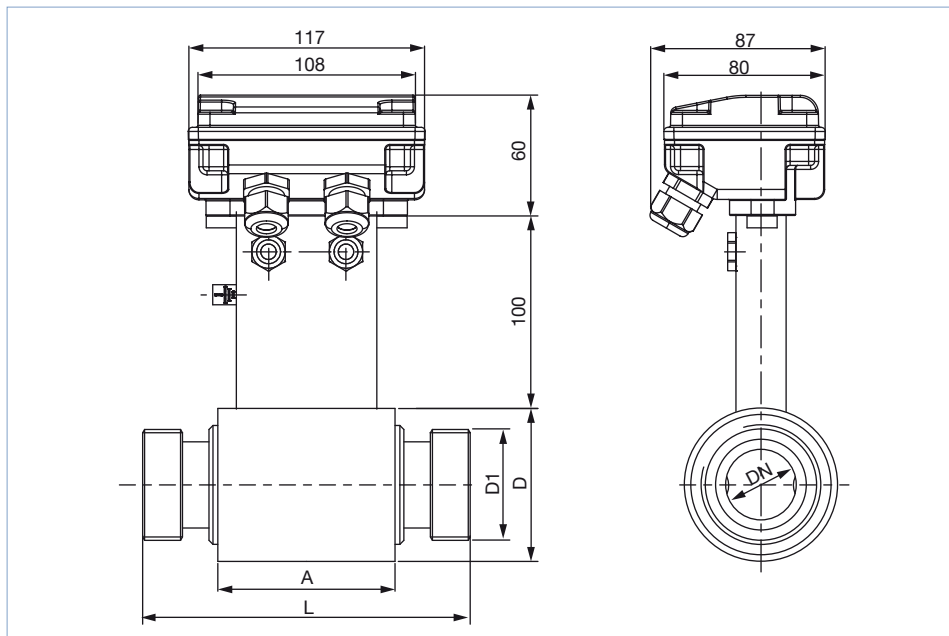

DN	A	L	Process connection	D1	D		
03	77	128	DN 10	RD28 x 1/8	76		
06				RD28 x 1/8			
10				RD28 x 1/8			
15				DN 15		RD34 x 1/8	
20	100	180	DN 20	RD44 x 1/6	89		
25			DN 25	RD52 x 1/6			
32			DN 32	RD58 x 1/6			
40			DN 40	RD65 x 1/6			
50			DN 50	RD78 x 1/6		114	
65			DN 65	RD95 x 1/6		140	
80			200	DN 80		RD110 x 1/4	168
100				DN 100		RD130 x 1/4	

DTS 1000101313 EN Version: O Status: RL (released | freigegeben | validé) printed: 27.05.2020

### 3.3. Compact sanitary version according to clamp ISO 2852 or BS 4825

**Note:**

- Detailed information on the dimensions of the SE56 transmitter can be found in **data sheet Type SE56** ▶.
- Dimensions in mm (unless specified differently)

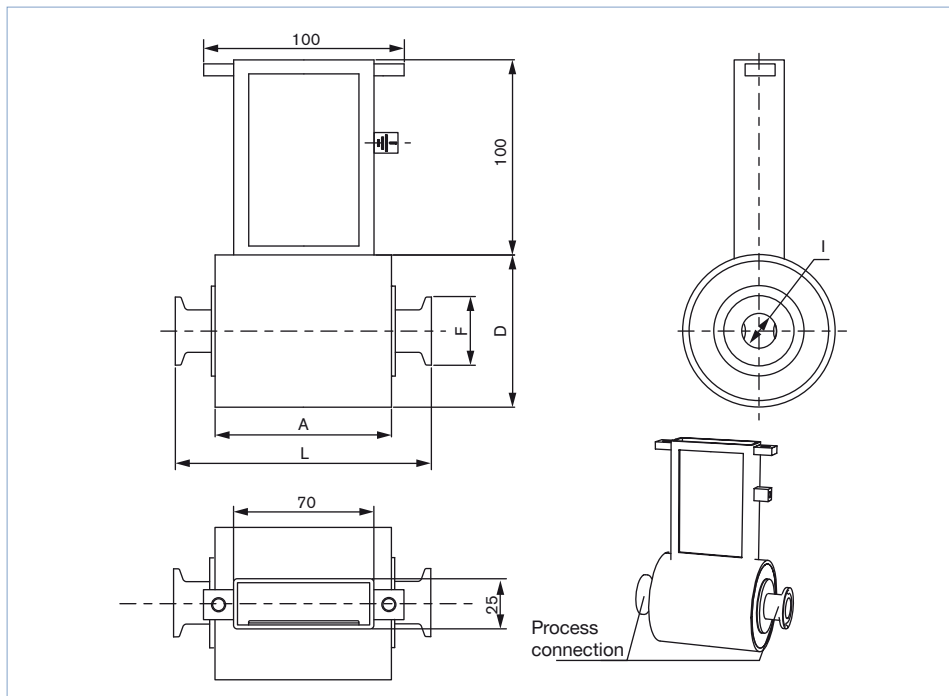

DN	A	L	Standard	F	D	I			
03	77	128	Clamp ISO 2852	34	76	12.7			
			Clamp BS 4825	25.4		9.5			
06			Clamp ISO 2852	34		12.7			
			Clamp BS 4825	25.4		9.5			
10			Clamp ISO 2852	34		12.7			
			Clamp BS 4825	25.4		9.5			
15			Clamp ISO 2852	34		17.2			
			Clamp BS 4825	25.4		15.85			
20			Clamp ISO 2852	34		21.3			
			Clamp BS 4825	50.5		22.2			
25	100	180	Clamp ISO 2852	50.5	89	22.6			
			Clamp BS 4825	50.5		22.2			
40			Clamp ISO 2852	50.5		35.6			
			Clamp BS 4825	50.5		34.9			
50			Clamp ISO 2852	64		48.6			
			Clamp BS 4825	64		47.6			
65			Clamp ISO 2852	77.5		60.3			
			Clamp BS 4825	77.5		60.3			
80			200	200		Clamp ISO 2852	91	180	72.9
						Clamp BS 4825	91		72.9
100	Clamp ISO 2852	119			97.6				
	Clamp BS 4825	119			97.6				

DTS 1000101313 EN Version: O Status: RL (released | freigegeben | valide) printed: 27.05.2020



**3.4. Remote sanitary version according to clamp ISO 2852 or BS 4825, with junction box**

**Note:**

- Detailed information on the dimensions of the SE56 transmitter can be found in **data sheet Type SE56** ▶.
- Dimensions in mm (unless specified differently)

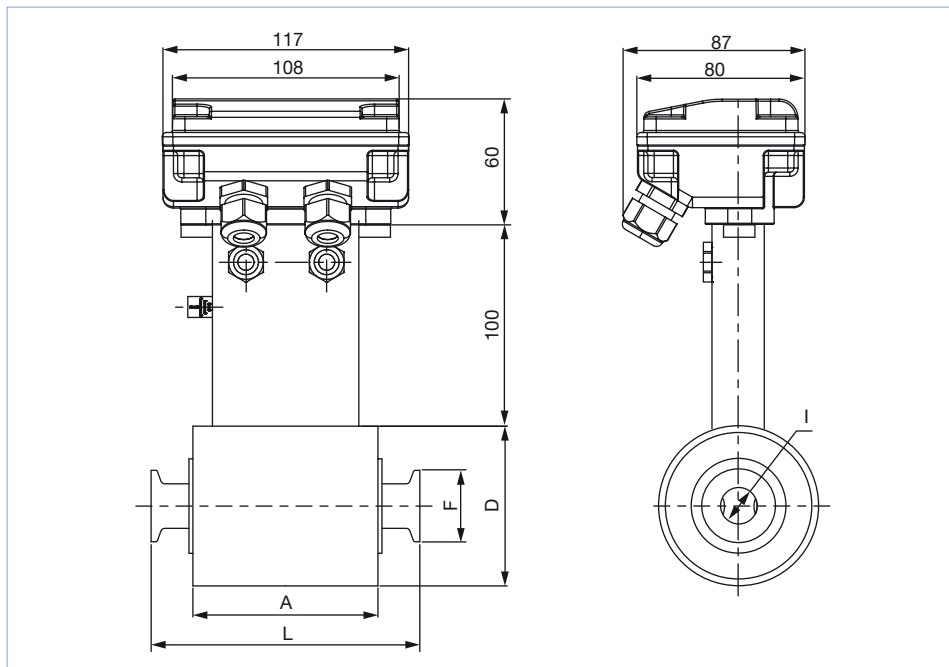

DN	A	L	Standard	F	D	I		
03	77	128	Clamp ISO 2852	34	76	12.7		
			Clamp BS 4825	25.4		9.5		
06			Clamp ISO 2852	34		12.7		
			Clamp BS 4825	25.4		9.5		
10			Clamp ISO 2852	34		12.7		
			Clamp BS 4825	25.4		9.5		
15			Clamp ISO 2852	34		17.2		
			Clamp BS 4825	25.4		15.85		
20			Clamp ISO 2852	34		21.3		
			Clamp BS 4825	50.5		22.2		
25	100	180	Clamp ISO 2852	50.5	76	22.6		
			Clamp BS 4825	50.5		22.2		
40			Clamp ISO 2852	50.5	89	35.6		
			Clamp BS 4825	50.5	34.9			
50			Clamp ISO 2852	64	114	48.6		
			Clamp BS 4825	64	47.6			
65			Clamp ISO 2852	77.5	140	60.3		
			Clamp BS 4825	77.5		60.3		
80			200	200	Clamp ISO 2852	91	180	72.9
					Clamp BS 4825	91		72.9
100	Clamp ISO 2852	119			180	97.6		
	Clamp BS 4825	119				97.6		

DTS 1000101313 EN Version: O Status: RL (released | freigegeben | valide) printed: 27.05.2020

## 4. Product installation

### 4.1. Installation notes

**Note:**

The flow meter is not designed for gas and steam flow measurement.

- During flowmeter operation the pipe must be completely full.

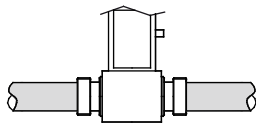

- Observe the upstream and downstream distances.

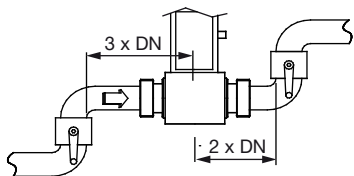

The sensor can be installed into either horizontal or vertical pipes. Mount the sensor in the below as correct indicated ways to obtain an accurate flow measurement.

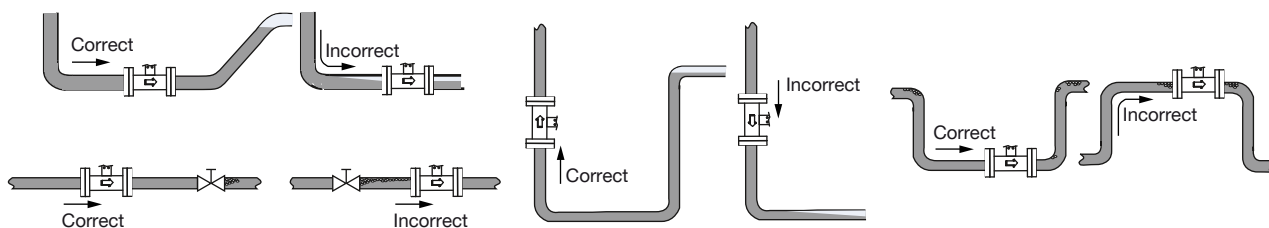

The suitable pipe size can be selected using the diagram for selecting the nominal diameter of the pipe.

See chapter [“4.2. Selection of the nominal diameter”](#) on page 11.

### 4.2. Selection of the nominal diameter

The graph is used to determine the DN of the pipe and the flowmeter appropriate to the application, according to the fluid velocity and the flow rate. On the chart, the intersection of flow rate and flow velocity gives the appropriate diameter.

**Example:**

- Flow: 10 l/min
- Optimal flow rate: 2...3 m/s

Result: Select a pipe size of DN 10

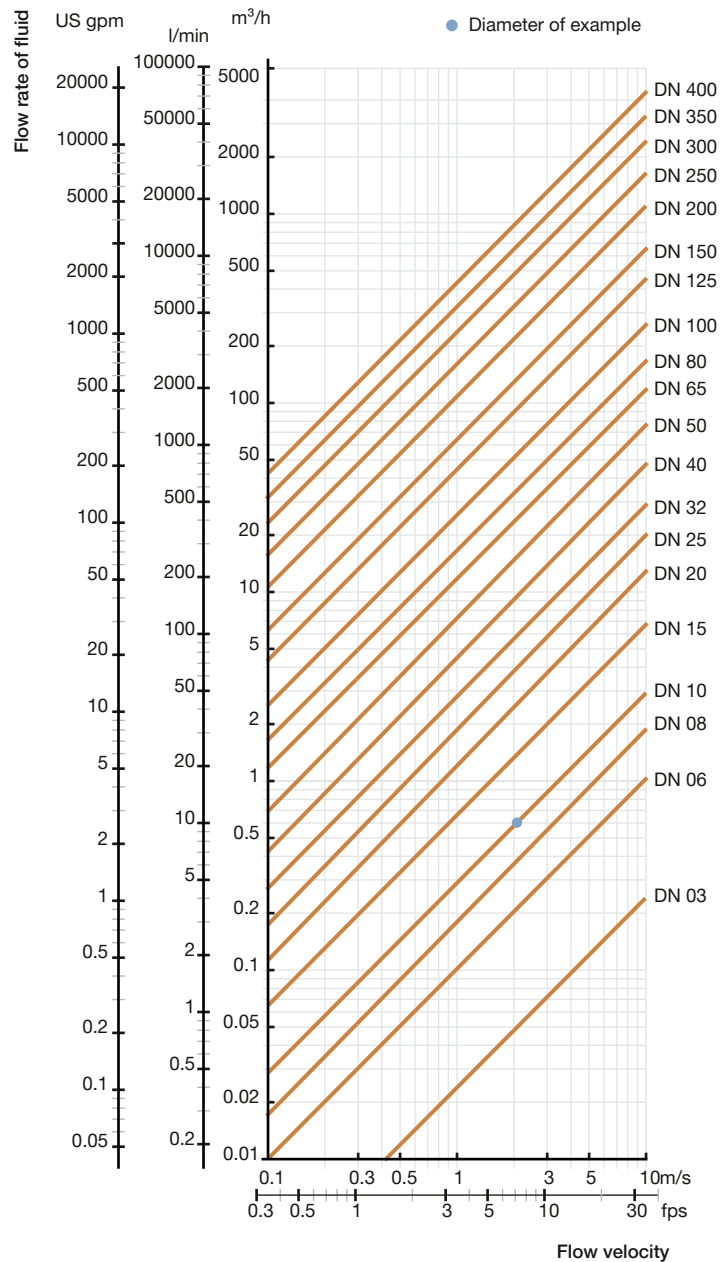

DTS 1000101313 EN Version: O Status: RL (released | freigegeben | validé) printed: 27.05.2020

## 5. Product operation

### 5.1. Measuring principle

Faraday's law serves as the physical basis for magnetic flow measurement.

Magnetic coils are arranged around the pipeline to generate a magnetic field. Conductive liquids flowing through the magnetic field induce a voltage at two opposite metallic electrodes in contact with the medium. These electrodes are used to measure the induced electrical alternating voltage.

The signal of sensor S056 must be amplified and processed by transmitter SE56. The transmitter delivers a signal proportional to the flow velocity or flow rate at its current output (4...20 mA) or at its pulse output. Depending on the application, both the 4 mA and the 20 mA limits can be assigned values in physical units such as l/min.

## 6. Ordering information

### 6.1. Bürkert eShop – Easy ordering and quick delivery



#### Bürkert eShop – Easy ordering and fast delivery

You want to find your desired Bürkert product or spare part quickly and order directly? Our online shop is available for you 24/7. Sign up and enjoy all the benefits.

[Order online now](#)

### 6.2. Recommendation regarding product selection

A complete 8056 flowmeter consists of a S056 flow sensor (compact or remote version) and a SE56 transmitter (compact or remote version).

See [Data sheet Type SE56](#) ▶ for more information.

Two different components must be ordered in order to select a complete device. The following information is required:

- **Article no.** of the sensor **Type S056** (see following ordering chart)
- **Article no.** of the transmitter **Type SE56** (see [data sheet Type SE56](#) ▶ for more information)

### 6.3. Bürkert product filter

































#### Bürkert product filter – Get quickly to the right product

You want to select products comfortably based on your technical requirements? Use the Bürkert product filter and find suitable articles for your application quickly and easily.

[Try out our product filter](#)

## 6.4. Ordering chart sensor Type S056

DN [mm]	Process connection	Flow rate range		Housing material	Wetted parts materials			Article no.
		Min. 0...0.4 m³/s	Max. 0...10 m³/s		Electrode <sup>1)</sup>	Seal	Lining	
<b>Sensor Type S056, compact version</b>								
03	DIN 11851	0...0,01 m³/h	0...0,25 m³/h	Stainless steel 304	Stainless steel 316L	FKM	PTFE	555732 
	Clamp ISO 2852							554004 
	Clamp BS 4825							559786 
06	DIN 11851	0...0,04 m³/h	0...1 m³/h	Stainless steel 304	Stainless steel 316L	FKM	PTFE	559430 
	Clamp ISO 2852							559431 
	Clamp BS 4825							553325 
10	DIN 11851	0...0,12 m³/h	0...3 m³/h	Stainless steel 304	Stainless steel 316L	FKM	PTFE	559432 
	Clamp ISO 2852							554904 
	Clamp BS 4825							554350 
15	DIN 11851	0...0,24 m³/h	0...6 m³/h	Stainless steel 304	Stainless steel 316L	FKM	PTFE	553527 
	Clamp ISO 2852							553555 
	Clamp BS 4825							553533 
20	DIN 11851	0...0,50 m³/h	0...12,5 m³/h	Stainless steel 304	Stainless steel 316L	FKM	PTFE	553528 
	Clamp ISO 2852							559433 
	Clamp BS 4825							553534 
25	DIN 11851	0...0.72 m³/h	0...18 m³/h	Stainless steel 304	Stainless steel 316L	FKM	PTFE	553486 
	Clamp ISO 2852							554151 
	Clamp BS 4825							553535 
32	DIN 11851	0...1.16 m³/h	0...29 m³/h	Stainless steel 304	Stainless steel 316L	FKM	PTFE	553529 
40	DIN 11851	0...1.80 m³/h	0...45 m³/h					553530 
								Clamp BS 4825
50	DIN 11851	0...2.88 m³/h	0...72 m³/h	Stainless steel 304	Stainless steel 316L	FKM	PTFE	553536 
	Clamp ISO 2852							553531 
	Clamp BS 4825							555120 
65	DIN 11851	0...4.80 m³/h	0...120 m³/h	Stainless steel 304	Stainless steel 316L	FKM	PTFE	553537 
	Clamp ISO 2852							553532 
	Clamp BS 4825							554116 
80	DIN 11851	0...7.20 m³/h	0...180 m³/h	Stainless steel 304	Stainless steel 316L	FKM	PTFE	553538 
	Clamp ISO 2852							555089 
	Clamp BS 4825							559434 
100	DIN 11851	0...11.20 m³/h	0...280 m³/h	Stainless steel 304	Stainless steel 316L	FKM	PTFE	559791 
	Clamp ISO 2852							On request
	Clamp BS 4825							On request

DN [mm]	Process connection	Flow rate range		Housing material	Wetted parts materials			Article no.
		Min. 0...0.4 m³/s	Max. 0...10 m³/s		Electrode <sup>1.)</sup>	Seal	Lining	
<b>Sensor Type S056, remote version with junction box and 10 m electrodes and coils cables (included)</b>								
03	DIN 11851	0...0,01 m³/h	0...0,25 m³/h	Stainless steel 304	Stainless steel 316L	FKM	PTFE	551506
	Clamp ISO 2852							551501
	Clamp BS 4825							559787
06	DIN 11851	0...0,04 m³/h	0...1 m³/h	Stainless steel 304	Stainless steel 316L	FKM	PTFE	551507
	Clamp ISO 2852							551502
	Clamp BS 4825							559788
10	DIN 11851	0...0,12 m³/h	0...3 m³/h	Stainless steel 304	Stainless steel 316L	FKM	PTFE	551508
	Clamp ISO 2852							551503
	Clamp BS 4825							559759
15	DIN 11851	0...0,24 m³/h	0...6 m³/h	Stainless steel 304	Stainless steel 316L	FKM	PTFE	551509
	Clamp ISO 2852							551504
	Clamp BS 4825							554082
20	DIN 11851	0...0,50 m³/h	0...12,5 m³/h	Stainless steel 304	Stainless steel 316L	FKM	PTFE	551510
	Clamp ISO 2852							551505
	Clamp BS 4825							553925
25	DIN 11851	0...0.72 m³/h	0...18 m³/h	Stainless steel 304	Stainless steel 316L	FKM	PTFE	448480
	Clamp ISO 2852							448499
	Clamp BS 4825							559789
32	DIN 11851	0...1.16 m³/h	0...29 m³/h	Stainless steel 304	Stainless steel 316L	FKM	PTFE	448481
	Clamp ISO 2852							448482
	Clamp BS 4825							448501
40	DIN 11851	0...1.80 m³/h	0...45 m³/h	Stainless steel 304	Stainless steel 316L	FKM	PTFE	554147
	Clamp ISO 2852							448483
	Clamp BS 4825							448502
50	DIN 11851	0...2.88 m³/h	0...72 m³/h	Stainless steel 304	Stainless steel 316L	FKM	PTFE	554138
	Clamp ISO 2852							448484
	Clamp BS 4825							448503
65	DIN 11851	0...4.80 m³/h	0...120 m³/h	Stainless steel 304	Stainless steel 316L	FKM	PTFE	559790
	Clamp ISO 2852							448485
	Clamp BS 4825							448504
80	DIN 11851	0...7.20 m³/h	0...180 m³/h	Stainless steel 304	Stainless steel 316L	FKM	PTFE	558854
	Clamp ISO 2852							448486
	Clamp BS 4825							448505
100	DIN 11851	0...11.20 m³/h	0...280 m³/h	Stainless steel 304	Stainless steel 316L	FKM	PTFE	On request
	Clamp ISO 2852							
	Clamp BS 4825							

1.) Two measuring electrodes

#### Further versions on request



**Process connection**  
SMS 1146 (from DN 10)



**Material**  
Seal: EPDM

6.5. Ordering chart accessories

Accessories for remote sensor	No.	Description	Article no.
	1	10 m cable for electrodes <sup>1.)</sup> For connecting the sensor ( <b>version without junction box</b> ) Type S051, S054, S055 or S056 to the connecting box of the cable extension kit.	448518
	2	10 m cable for coils <sup>1.)</sup> For connecting the sensor ( <b>version without junction box</b> ) Type S051, S054, S055 or S056 to the connecting box of the cable extension kit.	448519
	3	10 m cable for electrodes <sup>1.)</sup> For connecting <ul style="list-style-type: none"> <li>the connecting box of the cable extension kit to the transmitter Type SE56</li> <li>the sensor (<b>version with junction box</b>) Type S051, S054, S055 or S056 to the transmitter Type SE56</li> </ul>	562851
	4	10 m cable for coils <sup>1.)</sup> For connecting <ul style="list-style-type: none"> <li>the connecting box of the cable extension kit to the transmitter Type SE56</li> <li>the sensor (<b>version with junction box</b>) Type S051, S054/ S055 or S056 to the transmitter Type SE56</li> </ul>	562852
	5	Connecting box of the cable extension kit including No. 1 +2 +3 +4 and resin	562853

1.) Other cables length than 10 m on request (for cables length >20 m a preamplifier could be needed. **Caution, this will result in a price increase!**)

DTS 1000101313 EN Version: O Status: RL (released | freigegeben | validé) printed: 27.05.2020

# Bürkert – Close to You

For up-to-date addresses  
please visit us at  
[www.burkert.com](http://www.burkert.com)

DTS 1000101313 EN Version: O Status: RL (released | freigegeben | validé) printed: 27.05.2020

